

# MATENY HILL

## THE ANNAPOLIS

2-4 BR | 2-3 FULL BA | 1-2 HALF BA | 2-CAR GARAGE



# CRAFTMARK HOMES

**BETTER HOMES. BETTER LIVING.**

Artist's Conception

# Ground Floor

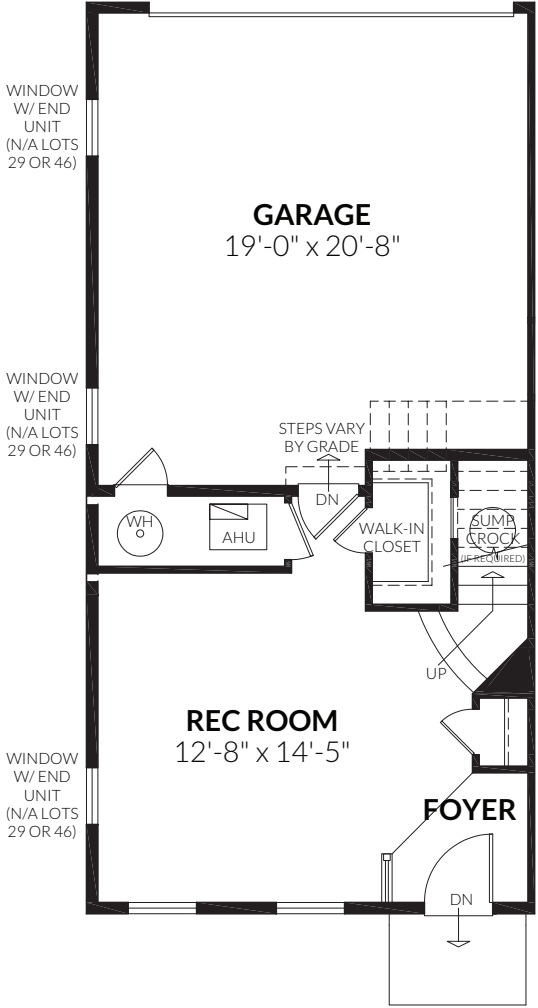

**STANDARD GROUND FLOOR**

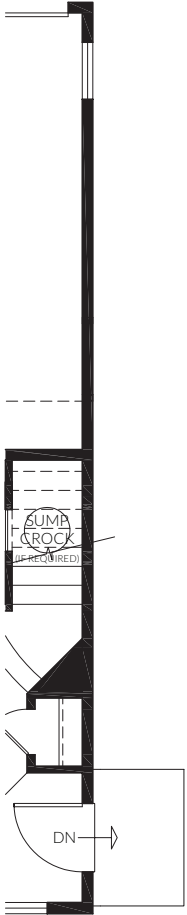

**END**  
Lot 29

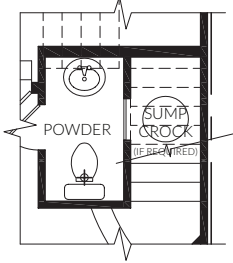

**OPT. POWDER ROOM**

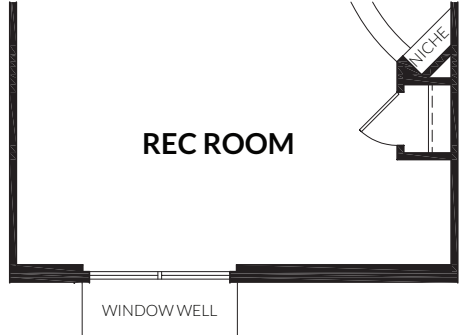

**GROUND FLOOR WITH BURIED BASEMENT**

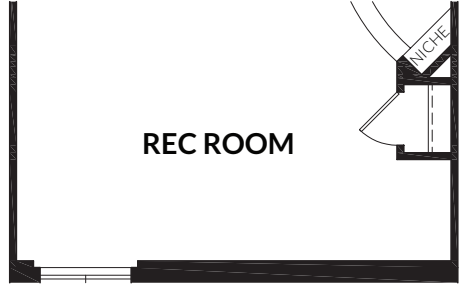

**GROUND FLOOR WITH ENGLISH BASEMENT**

# First Floor

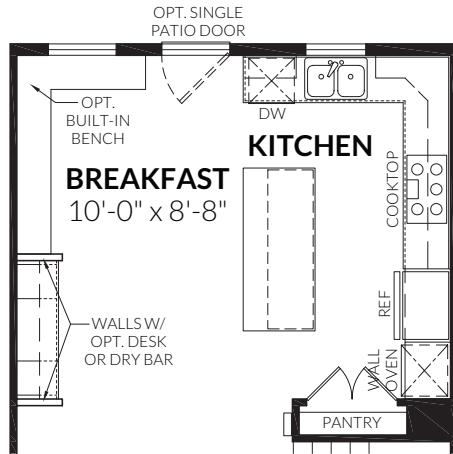

**ALTERNATE FIRST FLOOR  
KITCHEN & BREAKFAST**

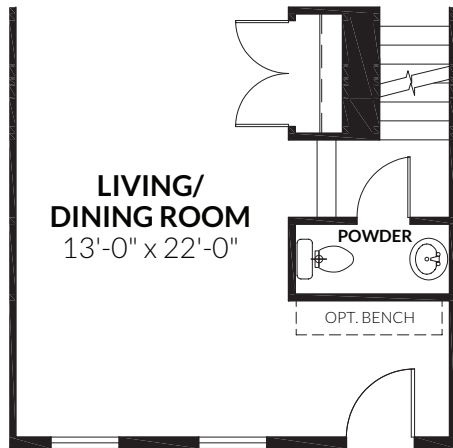

**FIRST FLOOR  
WITH BURIED & ENGLISH BASEMENT**

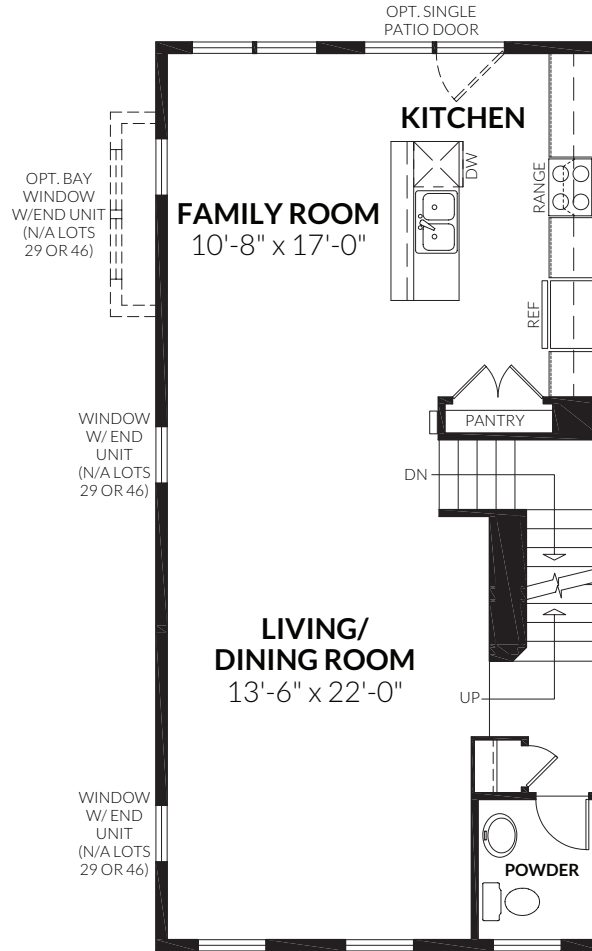

**STANDARD FIRST FLOOR**

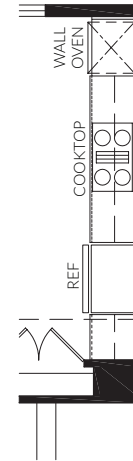

**OPT. GOURMET  
KITCHEN**

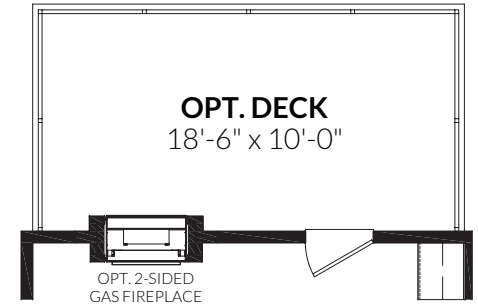

**OPT. GAS FIREPLACE  
WITH OPT. DECK**

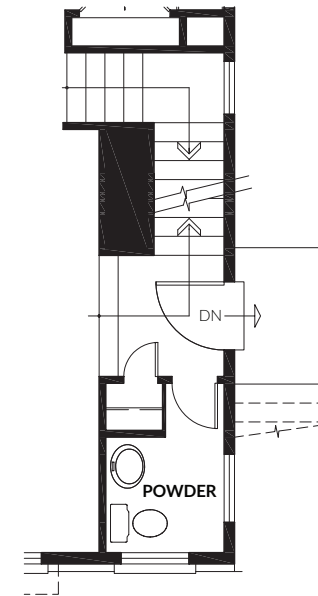

**END  
Lot 46  
(BURIED BASEMENT)**

CRAFTMARKHOMES.COM

All artist's renderings are concepts, may show optional features and are subject to change without notice. Ask Sales Manager for details.  
All floor plans and elevations are approximate and subject to change without notice. Room sizes and window configurations may vary with elevation.  
All dimensions noted represent widest point of room. Doors are not to scale and do not reflect actual door sizes.

# Second Floor

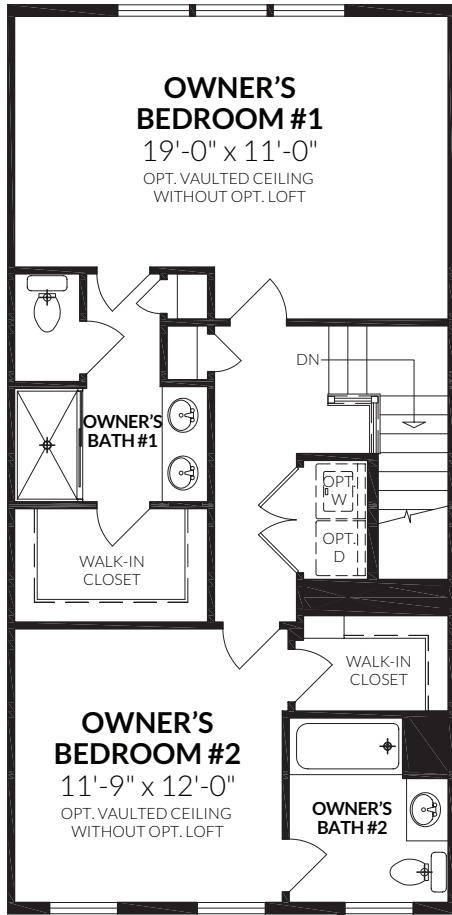

ALT. SECOND FLOOR

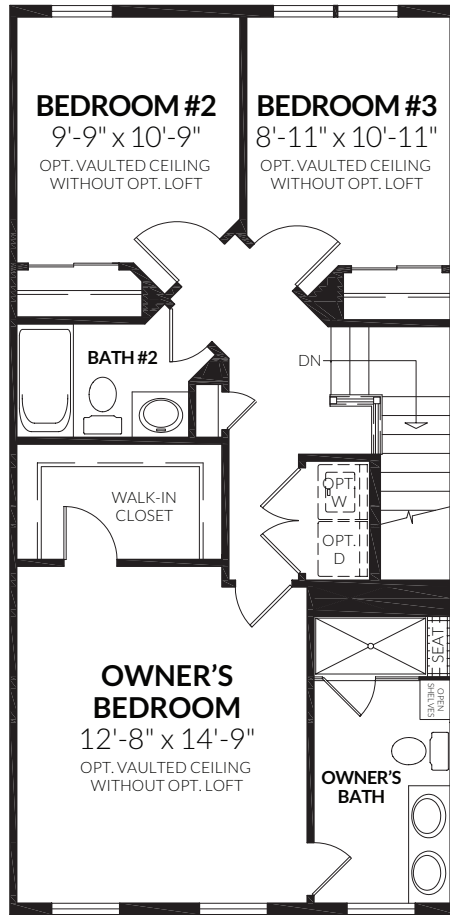

STANDARD SECOND FLOOR

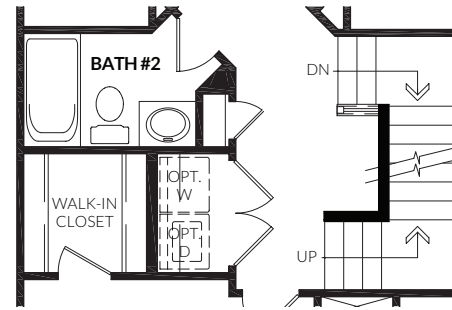

SECOND FLOOR WITH OPT. LOFT\*

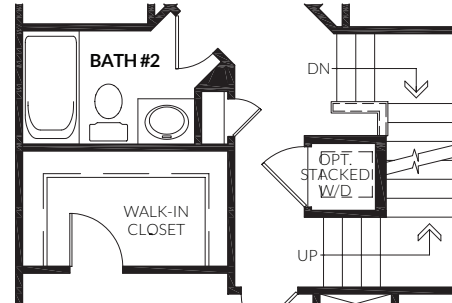

SECOND FLOOR WITH OPT. LOFT\*  
WITH OPT. STACKED WASHER/DRYER

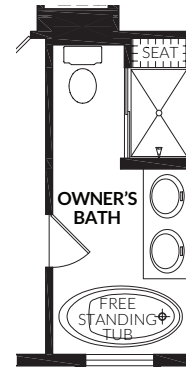

OWNER'S BATH  
WITH OPT. TUB &  
SHOWER  
(N/A W/ ALT.  
SECOND FLOOR)

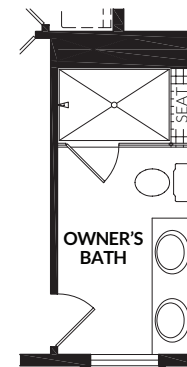

OWNER'S BATH  
WITH OPT. LARGE  
SHOWER IN LIEU  
OF SHELVES  
(N/A W/ ALT.  
SECOND FLOOR)

# Optional Loft\*

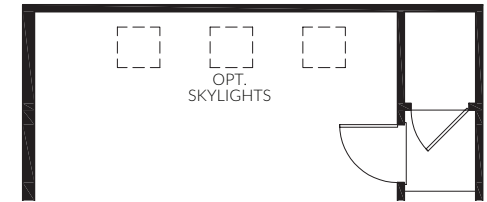

OPT. LOFT BEDROOM & BATH\*  
(END CONDITION)

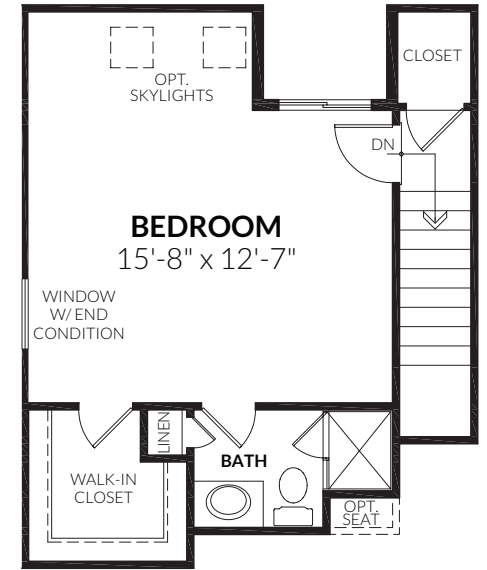

OPT. LOFT BEDROOM & BATH\*

CRAFTMARKHOMES.COM



03/17  
MHBR# 451

All artist's renderings are concepts, may show optional features and are subject to change without notice. Ask Sales Manager for details. All floor plans and elevations are approximate and subject to change without notice. Room sizes and window configurations may vary with elevation. All dimensions noted represent widest point of room. Doors are not to scale and do not reflect actual door sizes. \*Loft bedrooms/baths are subject to availability set by jurisdictions.

